

VONGE

121709 / 910-216-1050

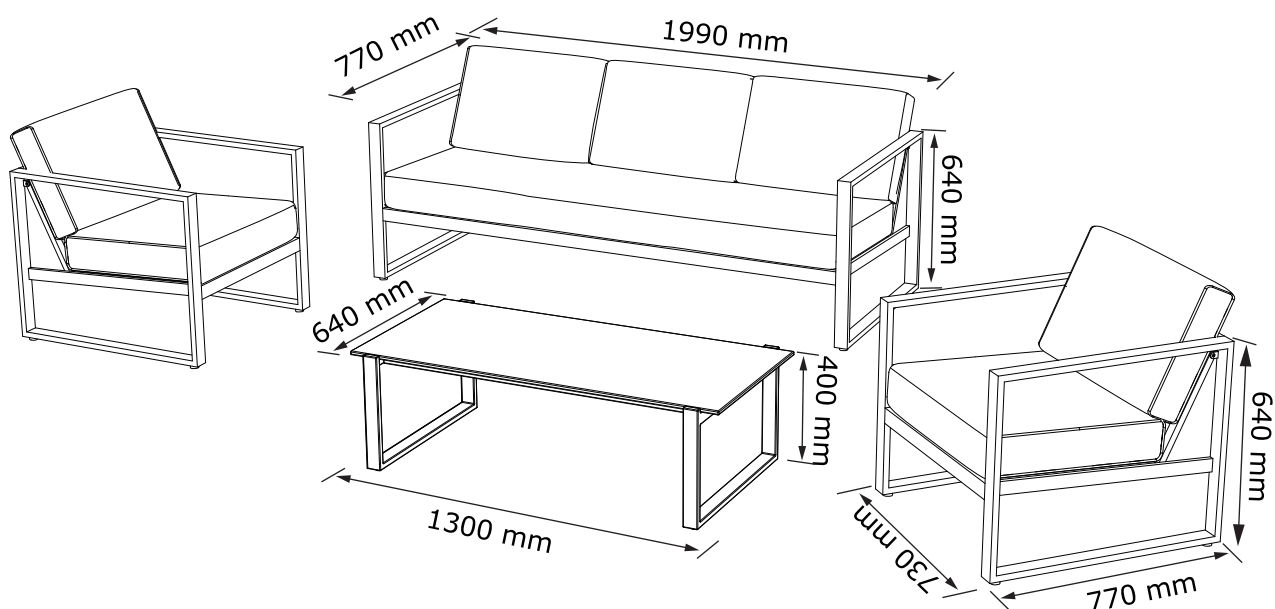

JUTLANDIA®



JYSK.com



FR

Pensez à
donner ou recycler.



Association

ou



Magasin

ou



Déchèterie

<https://quefairemesdechets.fr>

EN: *IMPORTANT, RETAIN FOR FUTURE REFERENCE: READ CAREFULLY.*

FR: *IMPORTANT, À CONSERVER POUR TOUTE CONSULTATION ULTÉRIEURE: LIRE ATTENTIVEMENT.*

LV: *SVARĪGI, SAGLABĀJIET TURPMĀKAI UZZIŅAI: RŪPĪGI IZLASIET.*

LT: *SVARBU, PASILIKITE ATEIČIAI, ATIDŽIAI PERSKAITYKITE.*

EE: *TÄHTIS! HOIDKE EDASPIDISEKS KASUTAMISEKS ALLES MÄRKUS. LUGEGE TÄHELEPANELIKULT.*

RU: *ВАЖНАЯ ИНФОРМАЦИЯ, СОХРАНИТЕ ДЛЯ ДАЛЬНЕЙШЕГО ИСПОЛЬЗОВАНИЯ. ПРОЧИТЕ ВНИМАТЕЛЬНО.*



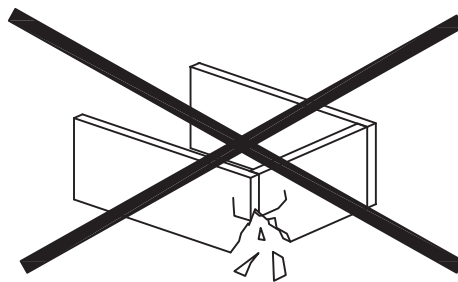
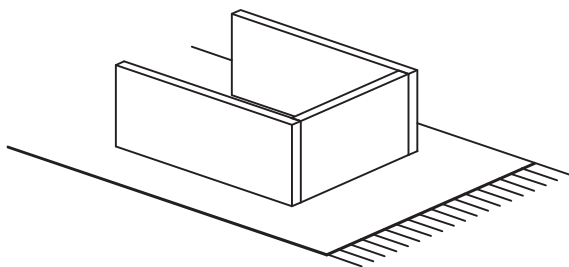

EN: WARNING TO AVOID SCRATCHES!

In order to avoid scratching this furniture should be assembled on a soft layer - could be a rug.

FR: AVERTISSEMENT POUR ÉVITER LES RAYURES

Afin d'éviter les rayures, ce meuble doit être monté sur une surface souple (un tapis, par exemple).

LV: BRĪDINĀJUMS PAR SKRĀPĒJUMIEM!

Lai nesaskrāpētu šo izstrādājumu, veiciet montāžu uz mīkstas pamatnes, piemēram, paklāja.

LT: ĮSPĖJIMAS, KAD IŠVENGTUMĖTE ĮBRĖŽIMŲ!

Šio baldo nesubraižysite, jei jį surinksite ant švelnaus paviršiaus, pavyzdžiui, kilimo.

EE: HOIATUS KRIIMUSTUSTE VÄLTIMISEKS!

Kriimustuste tekkimise vältimiseks mööblile tuleb see kokku panna pehmel pinnal, nt kaltsuvaibal.

RU: ПРЕДУПРЕЖДЕНИЕ ОТНОСИТЕЛЬНО ЦАРАПИН!

Во избежание нанесения царапин, сборку этой мебели необходимо выполнять на мягкой поверхности, например на ковре.

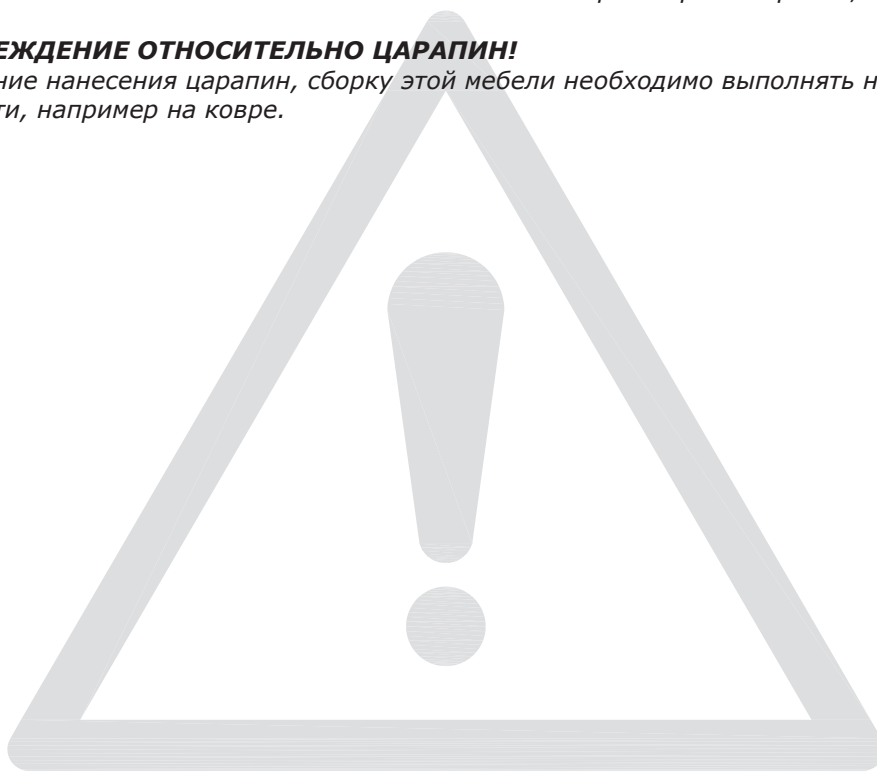

EN: IMPORTANT!

It is important that any product which is assembled using any kind of screw is re-tightened 2 weeks after assembly, and once every 3 months - in order to assure stability through-out the lifespan of the product.

FR: IMPORTANT

Il est important que tout produit monté à l'aide de vis soit resserré 2 semaines après son montage, puis tous les 3 mois, afin de garantir sa stabilité durant tout son cycle de vie.

LV: SVARĪGI!

Ir svarīgi, lai jebkuram produktam, kas tiek uzstādīts ar jebkādu skrūvju palīdzību, skrūves tiktu atkārtoti pievilktas 2 nedēļas pēc montāžas, pēc tam – reizi 3 mēnešos, tā nodrošinot stabilitāti visā izstrādājuma kalpošanas laikā.

LT: SVARBU!

Bet kokį varžtais tvirtinamą gaminį 2 savaites po surinkimo bei kas 3 mėnesius reikia papildomai suveržti – taip užtikrinamas naudojamo gaminio stabilumas.

EE: TÄHTIS!

Oluline on, et toote kruvisid pingutataks 2 nädalat pärast kokkupanekut ja seejärel iga 3 kuu järel, et tagada stabiilsus kogu toote eluea jooksul.

RU: ВАЖНО!

В любом изделии, собранном с использованием винтов любого типа, необходимо через 2 недели после сборки и в дальнейшем каждые 3 месяца подтягивать винты, чтобы обеспечить прочность изделия в течение срока эксплуатации.





EN: GENERAL INSTRUCTION FOR FURNITURE WITH FABRIC!

Wipe clean with a damp cloth. Use only clean water.

Dust and dirt can be vacuum cleaned or wiped with a clean soft cloth.

Do not use detergents, solvents or other chemicals on fabric as this may cause discoloration.

However, certain removable fabrics may be washed, but in such cases there will ALWAYS be a washing instruction on the fabric.

FR: INSTRUCTIONS GÉNÉRALES POUR LE MOBILIER EN TISSU!

Nettoyez à l'aide d'un chiffon humide. N'utilisez que de l'eau claire.

La poussière et la saleté peuvent être aspirées ou essuyées à l'aide d'un chiffon doux et propre.

N'utilisez aucun détergent, solvant ou autre produit chimique sur le tissu, car ceci pourrait le décolorer.

Cependant, certains tissus amovibles peuvent être lavés, mais dans ce cas le tissu comportera TOUJOURS des instructions de lavage.

LV: VISPĀRĪGI KOPŠANAS NORĀDĪJUMI MĒBELĒM AR AUDUMU!

Noslaukiet ar mitru drānu. Izmantojiet tikai tīru ūdeni.

Putekļus un netīrumus var notīrīt ar putekļusūcēju vai noslaucīt ar mīkstu drānu.

Auduma tīrīšanai neizmantojiet mazgāšanas līdzekļus, šķīdinātājus vai citas ķīmikālijas, jo auduma krāsa var izbalēt.

Atsevišķus noņemamos audumus var mazgāt, taču tad uz auduma VIENMĒR būs sniegti kopšanas norādījumi.

LT: BENDROSIOS INSTRUKCIJOS BALDAMS PADENGTIEMS AUDINIUI!

Švariai nušluostykite drėgna šluoste. Naudokite tik švarų vandenį.

Dulkės ir nešvarumai gali būti susiurbti arba nuvalyti švaria, minkšta šluoste.

Nenaudokite detergentų, tirpiklių ar kitų chemikalų audiniams, nes šie gali sukelti spalvos išblukimą.

Visgi, kai kurie nuimami audiniai gali būti skalbiami, bet tokiais atvejais ant audinio etiketės VISADA turi būti pateiktos skalbimo instrukcijos.

EE: ÜLDISED JUHISED KANGAGA MÖÖBLI JAOKS!

Puhastage niiske lapiga. Kasutage ainult puhast vett.

Tolmu ja mustust saab eemaldada tolmuimejaga või ära pühkida puhta pehme lapiga.

Ärge kasutage kangal pesuvahendeid, lahusteid või muid kemikaale, kuna see võib põhjustada värvimuutusi.

Küll aga võib teatud eemaldatavaid kangaid pesta, kuid sellisel juhul on kanga küljes ALATI pesujuhend.

RU: ОБЩИЕ УКАЗАНИЯ ПО УХОДУ ЗА МЕБЕЛЬЮ С ОТДЕЛКОЙ ИЗ ТКАНИ!

Очистите изделие чистой влажной тряпкой. Используйте только чистую воду.

Пыль и грязь можно удалять пылесосом или чистой мягкой тряпкой.

Не наносите моющие средства, растворители или другие химические вещества на ткань, поскольку они могут привести к вымыванию цвета.

Некоторые съемные элементы из ткани можно стирать. В таких случаях к ткани ОБЯЗАТЕЛЬНО прилагается инструкция по стирке.

EN: WARNING FOR SEATING FURNITURE!

Tested for 110 kg. per seat.

FR: AVERTISSEMENT POUR LE MOBILIER D'ASSISE!

Testé pour un poids de 110 kilos par assise.

LV: BRĪDINĀJUMS SĒDMĒBELĒM!

Testēts uz 110 kg (katrai sēdvietai).

LT: PERSPĖJIMAS DĖL BALDŲ, ANT KURIŲ SĖDIMA!

Išbandyta esant 110 kg apkrovai vienai vietai.



EE: HOIATUS TOOLI KASUTAMISE KOHTA!

Testitud 110 kg kaalu puhul istekohta kohta.

RU: ПРЕДУПРЕЖДЕНИЕ ДЛЯ МЯГКОЙ МЕБЕЛИ!

Максимально допустимый вес — 110 кг (на каждое место).



EN581		
		
✓	✓	✗

EN: *Domestic use.*

FR: *Pour la maison.*

LV: *Lietošanai mājas apstākļos.*

LT: *Skirta naudoti namų sąlygomis.*

EE: *Kodus kasutamiseks.*

RU: *Для домашнего использования.*

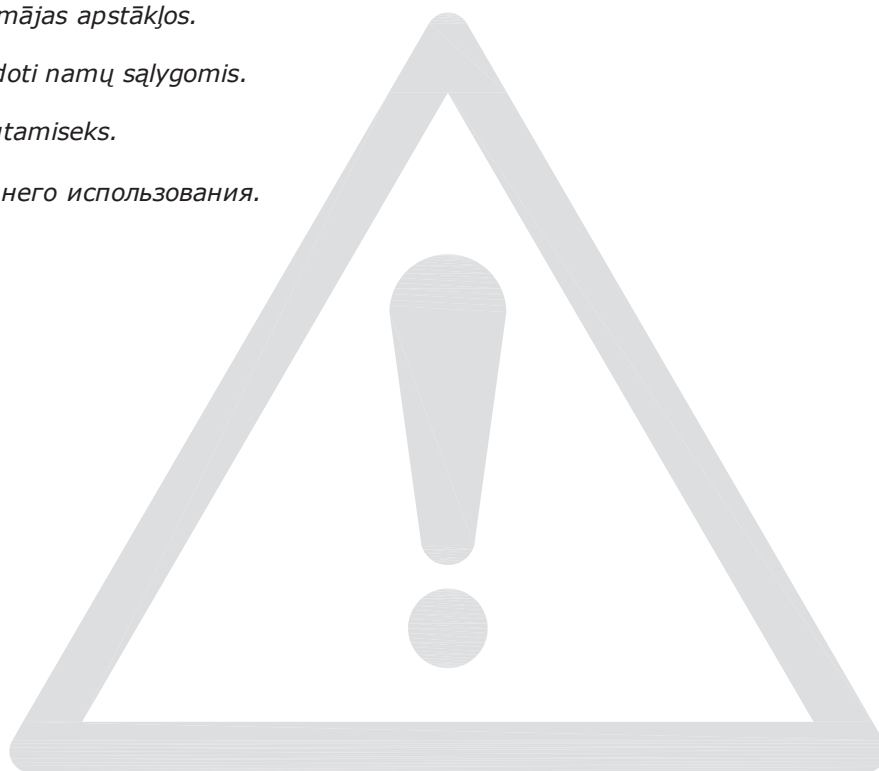

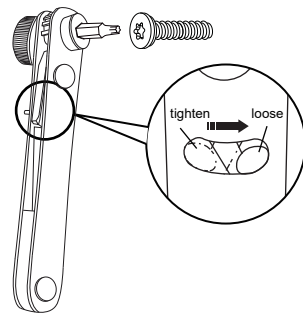
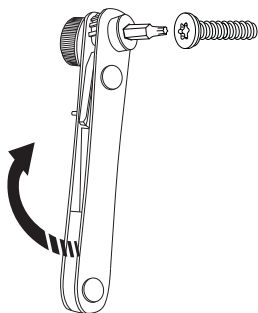
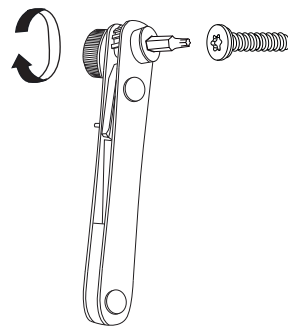
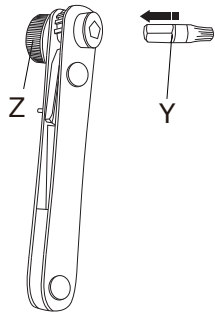
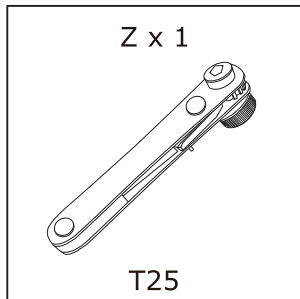
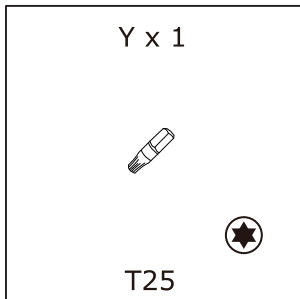
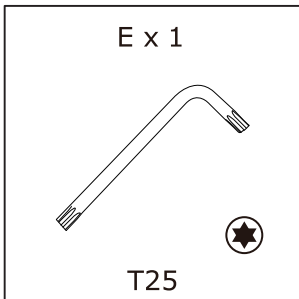
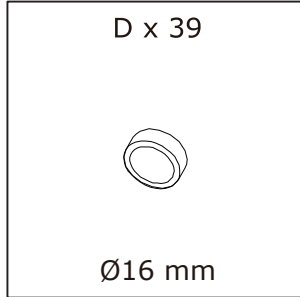
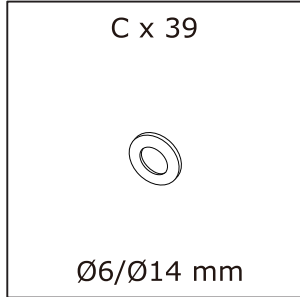
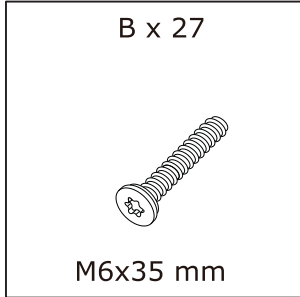
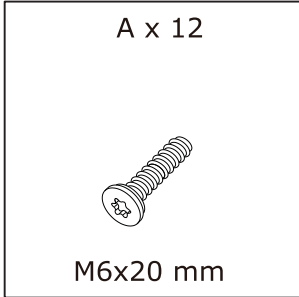
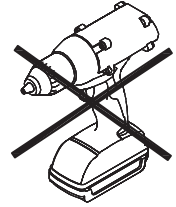

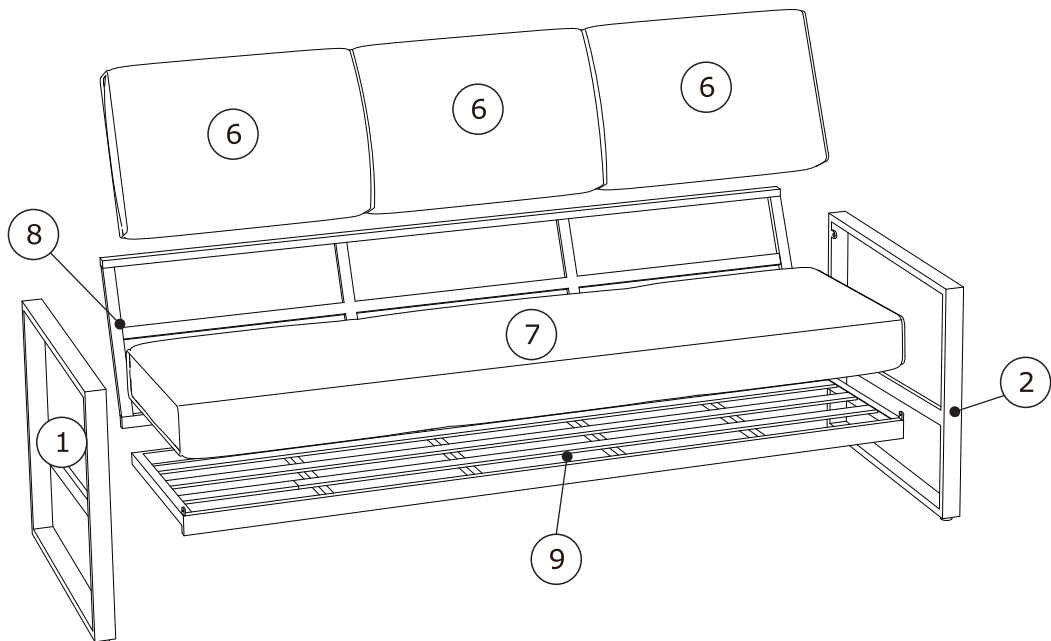
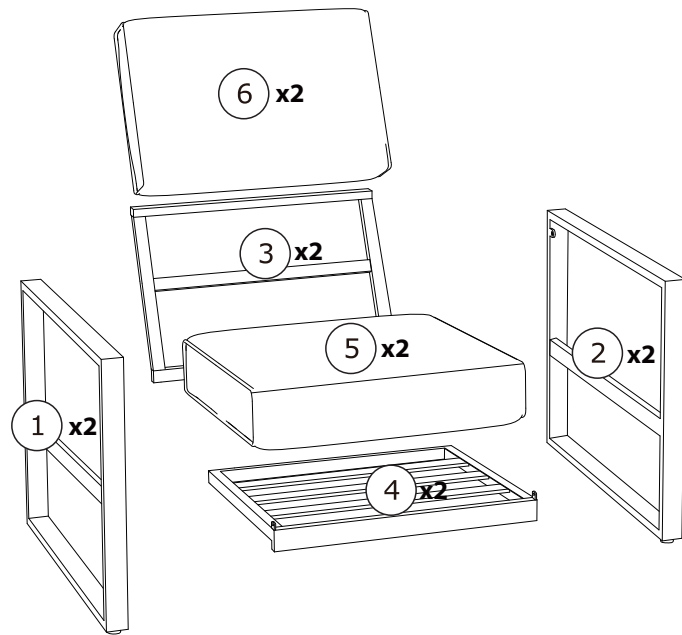

Box 1/2:

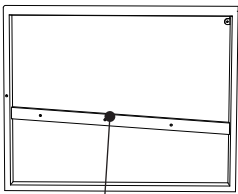

1 x3

770x640x50 mm

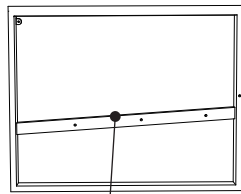

2 x3

770x640x50 mm

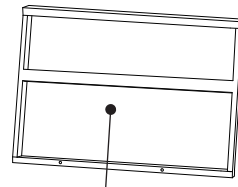

3 x2

630x445x30 mm



4 x2

630x570x50 mm

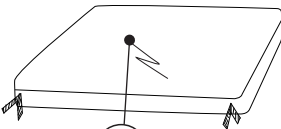

5 x2

630x630x120 mm

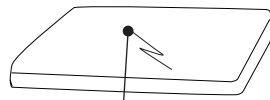

6 x5

630x430x130 mm

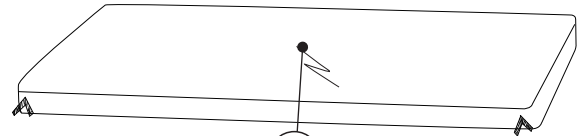

7

1890x630x120 mm

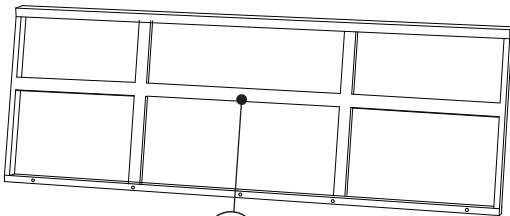

8

1890x445x30 mm

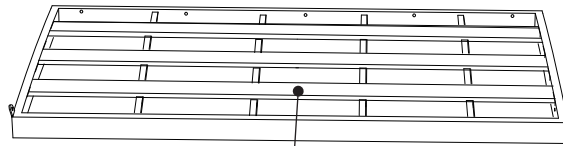

9

1890x570x50 mm

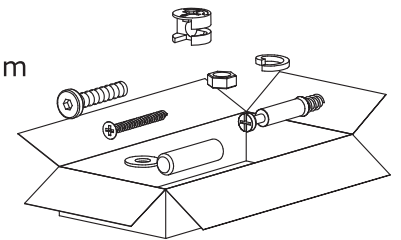

Box 2/2:

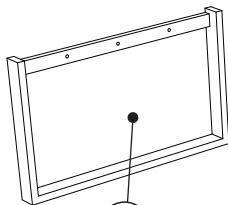

1 x2

640x400x50 mm

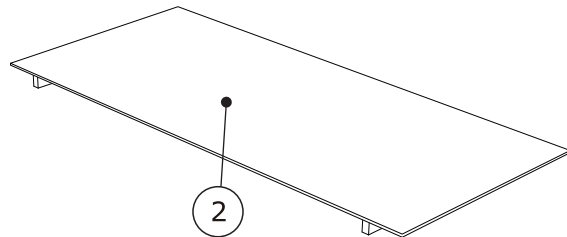



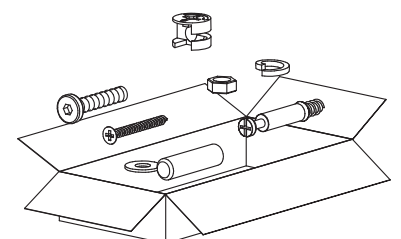

2

1300x600x45 mm





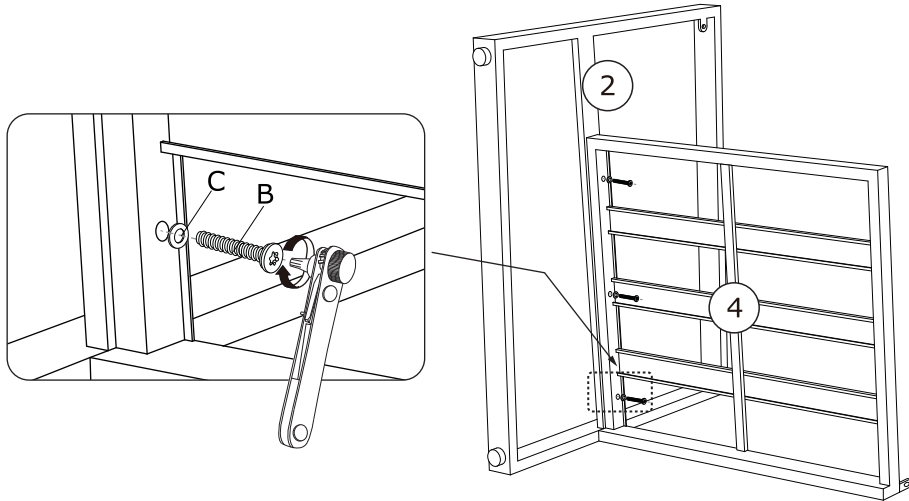
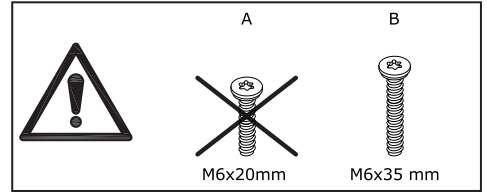
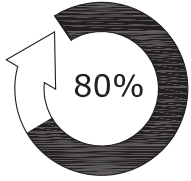

1

B x 6  M6x35 mm	C x 6  Ø6/Ø14 mm	E x 1  T25	Y x 1  T25	Z x 1  T25	
--	---	---	---	---	--



x2



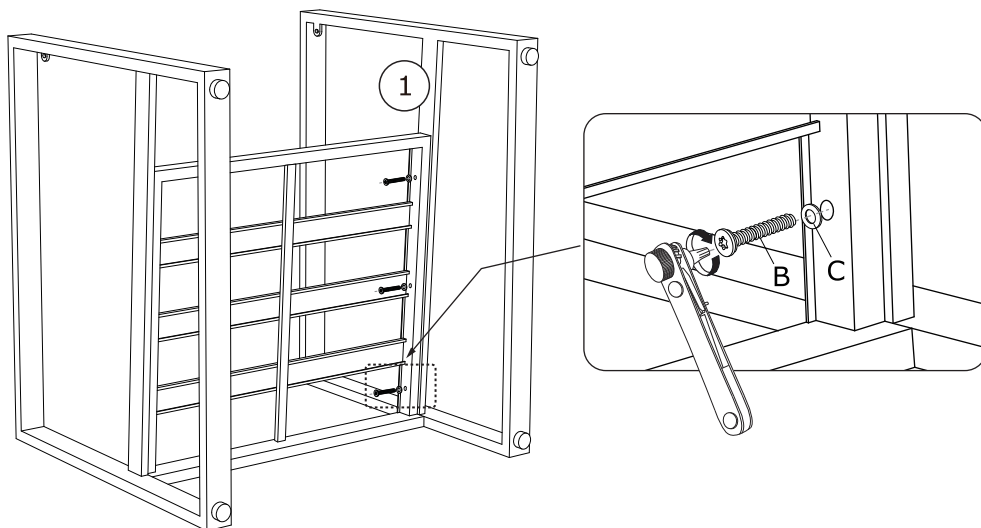
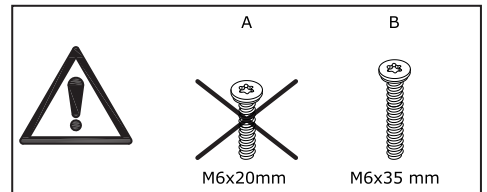
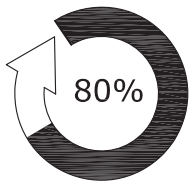

2

B x 6  M6x35 mm	C x 6  Ø6/Ø14 mm	E x 1  T25	Y x 1  T25	Z x 1  T25	
--	---	---	---	---	--



x2



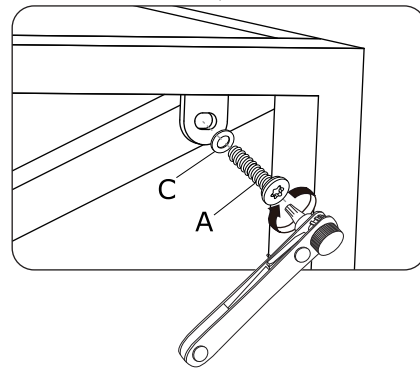
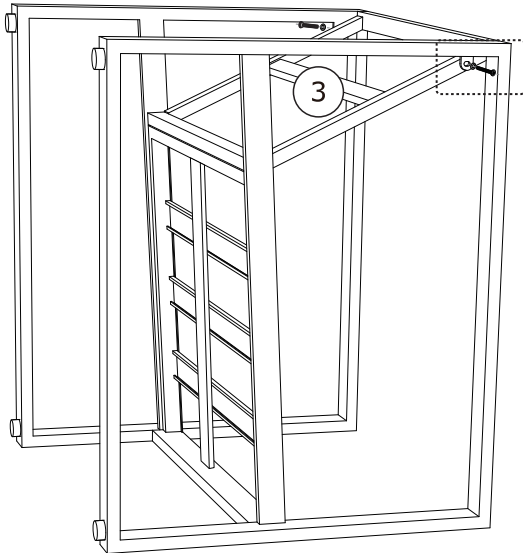
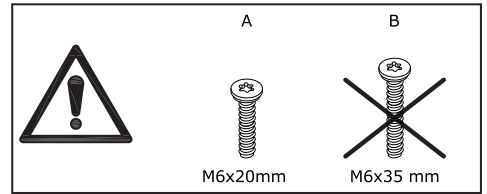
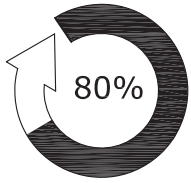

3

A x 4  M6x20 mm	C x 4  Ø6/Ø14 mm	E x 1  T25	Y x 1  T25	Z x 1  T25	
--	---	---	---	---	--



x2

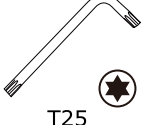

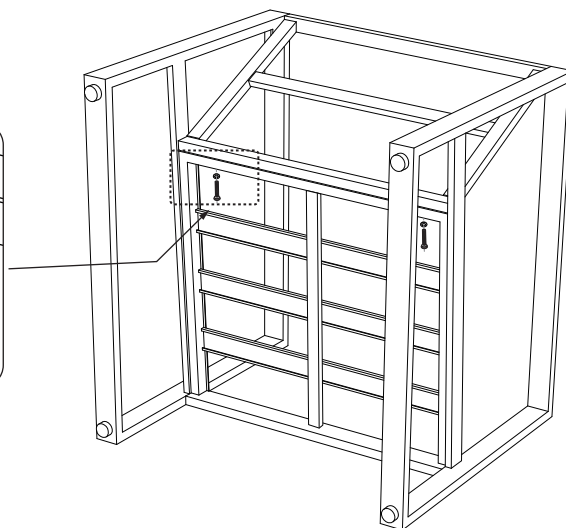
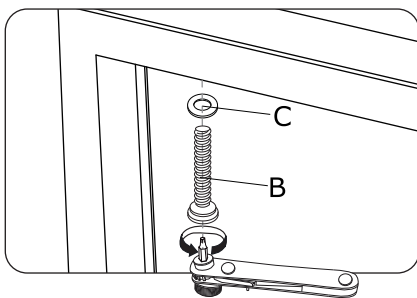
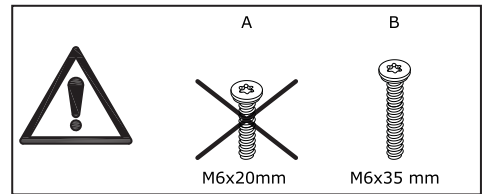
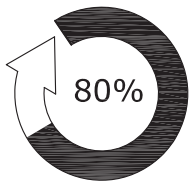

4

B x 4  M6x35 mm	C x 4  Ø6/Ø14 mm	E x 1  T25	Y x 1  T25	Z x 1  T25	
--	---	---	---	---	--



x2

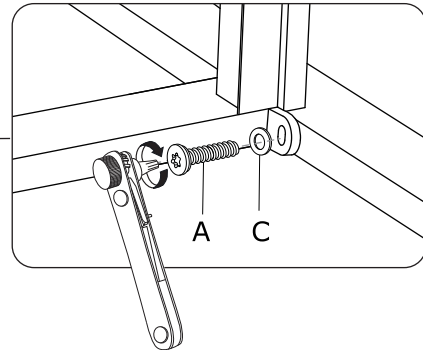
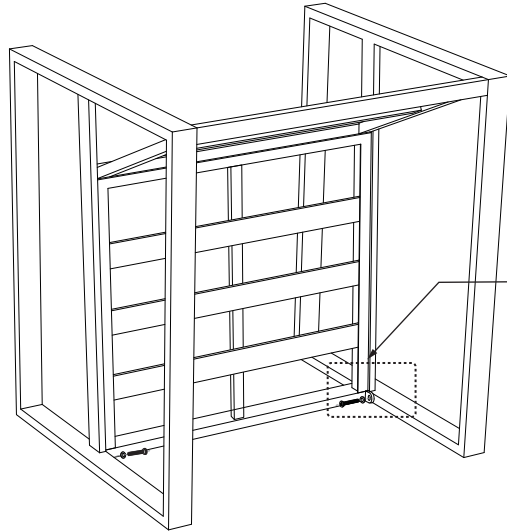
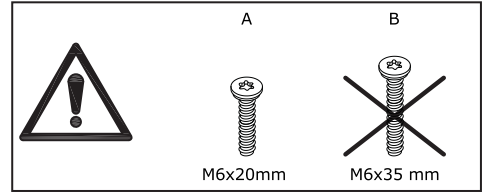
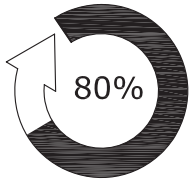

5

A x 4  M6x20 mm	C x 4  Ø6/Ø14 mm	E x 1  T25	Y x 1  T25	Z x 1  T25	
--	---	---	---	---	--



x2

6

E x 1  T25	Y x 1  T25	Z x 1  T25	
---	---	---	--

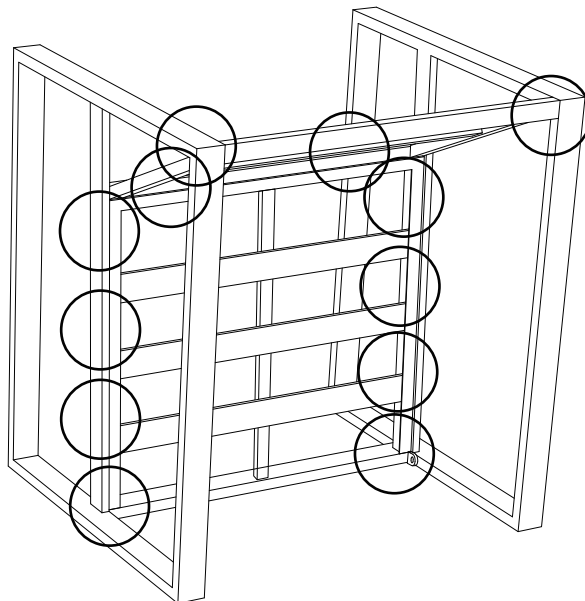
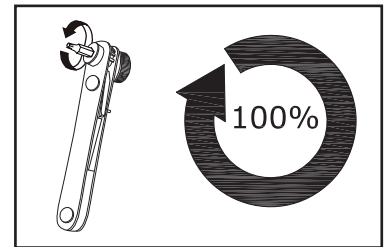

x2

7

D x 24



Ø16 mm

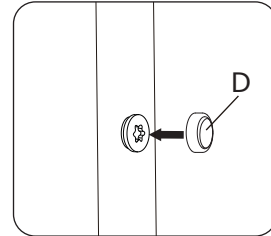
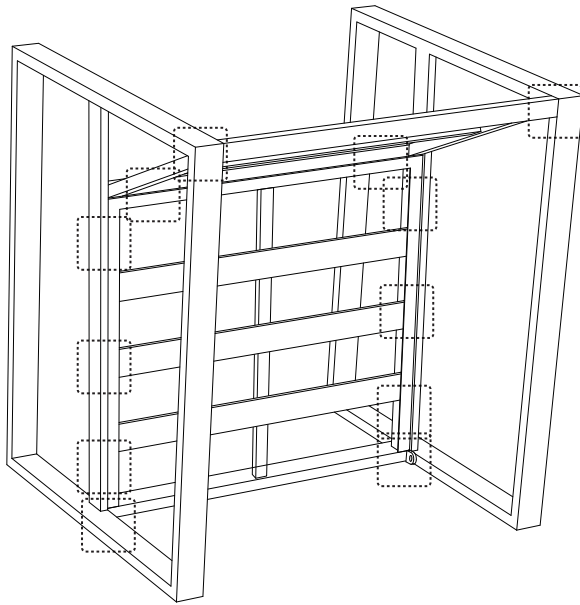

x2

8

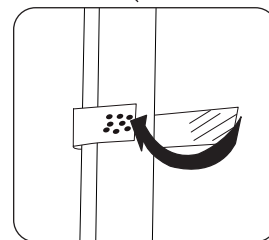
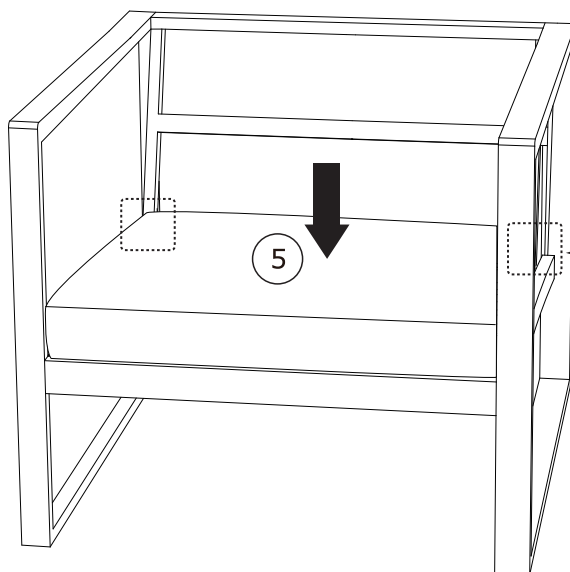



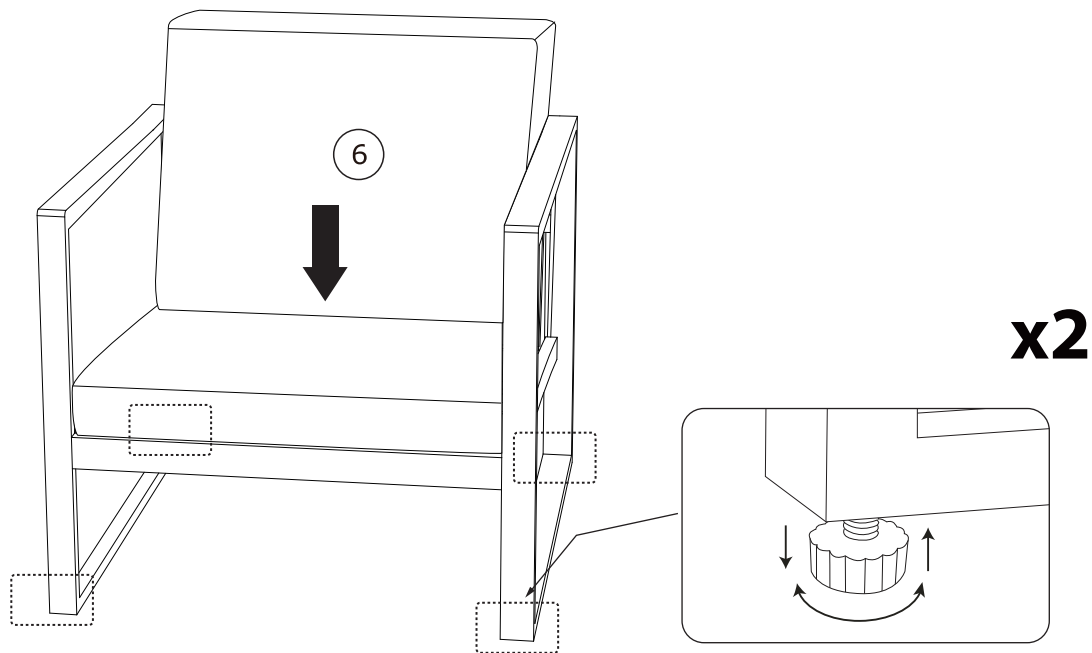

x2

9







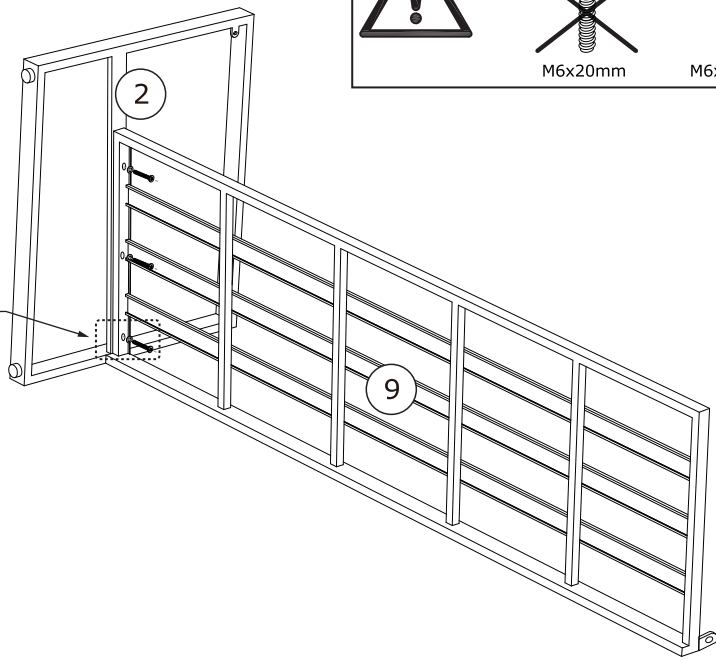
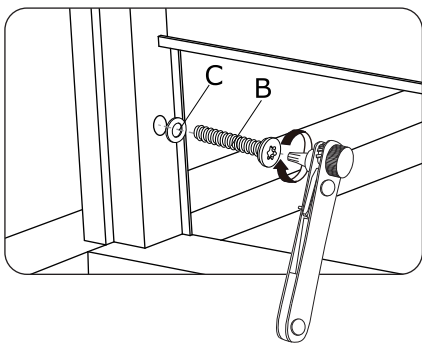
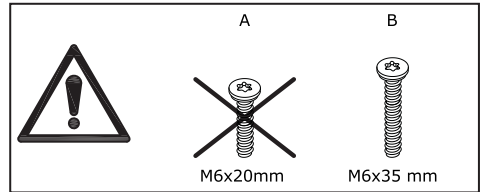
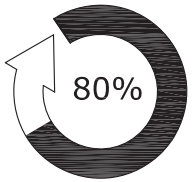

10

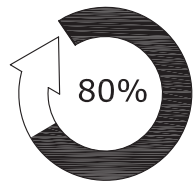
B x 3  M6x35 mm	C x 3  Ø6/Ø14 mm	E x 1  T25	Y x 1  T25	Z x 1  T25	
--	---	---	---	---	--



11





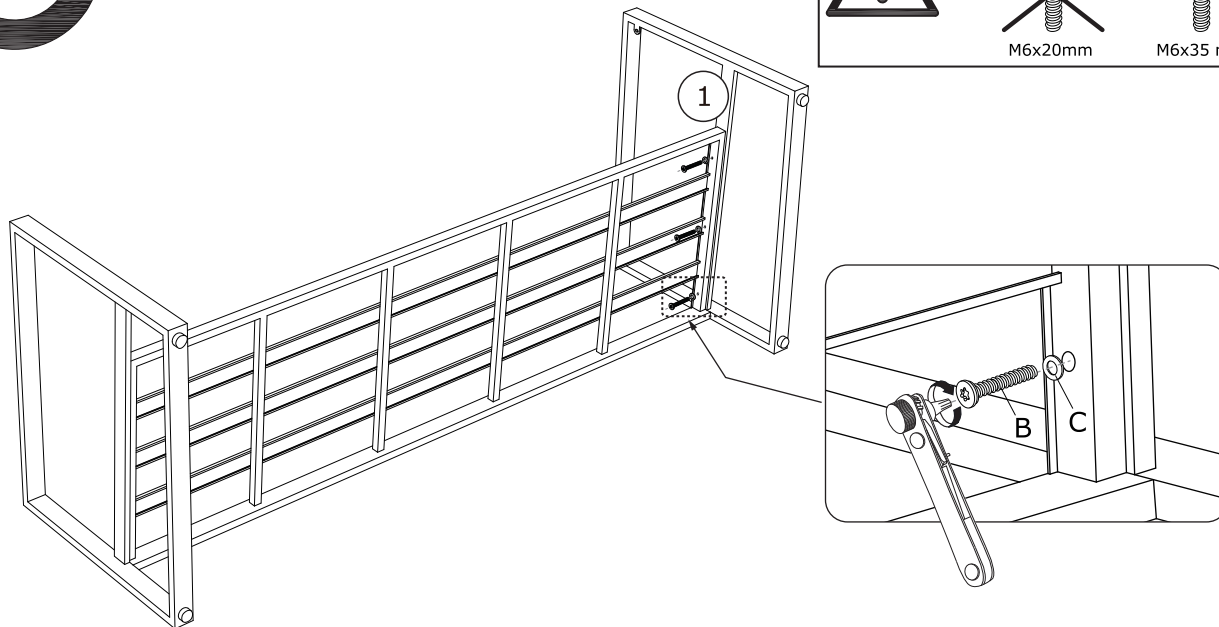
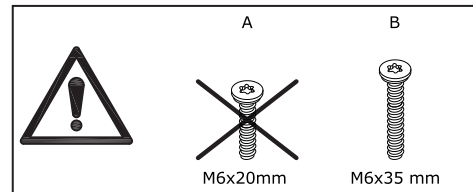

B x 3  M6x35 mm	C x 3  Ø6/Ø14 mm	E x 1  T25	Y x 1  T25	Z x 1  T25	
--	---	---	---	---	--

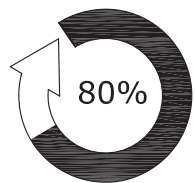





12

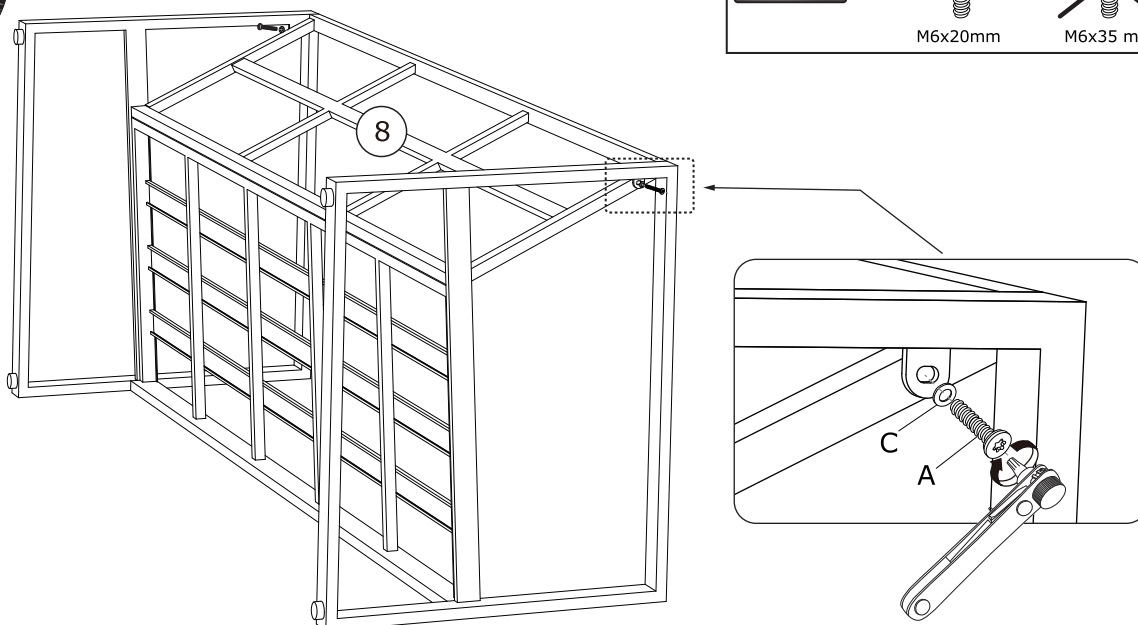
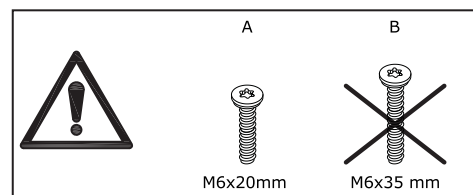

A x 2  M6x20 mm	C x 2  Ø6/Ø14 mm	E x 1  T25	Y x 1  T25	Z x 1  T25	
--	---	---	---	---	--





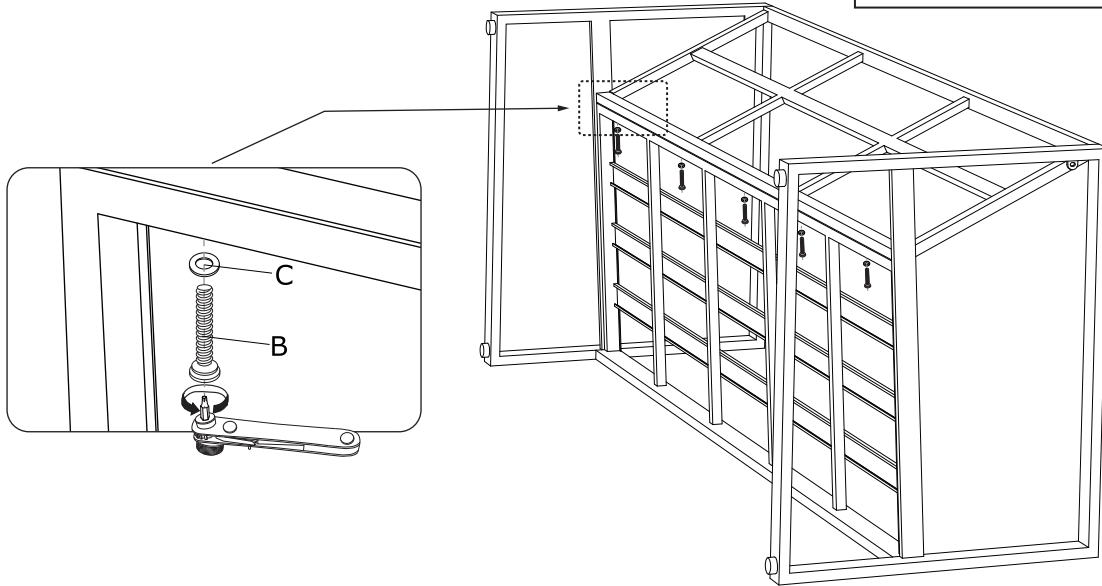
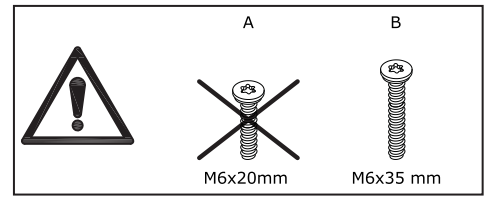
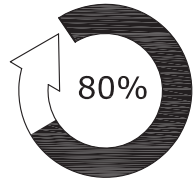

13

B x 5  M6x35 mm	C x 5  Ø6/Ø14 mm	E x 1  T25	Y x 1  T25	Z x 1  T25	
--	---	---	---	---	--



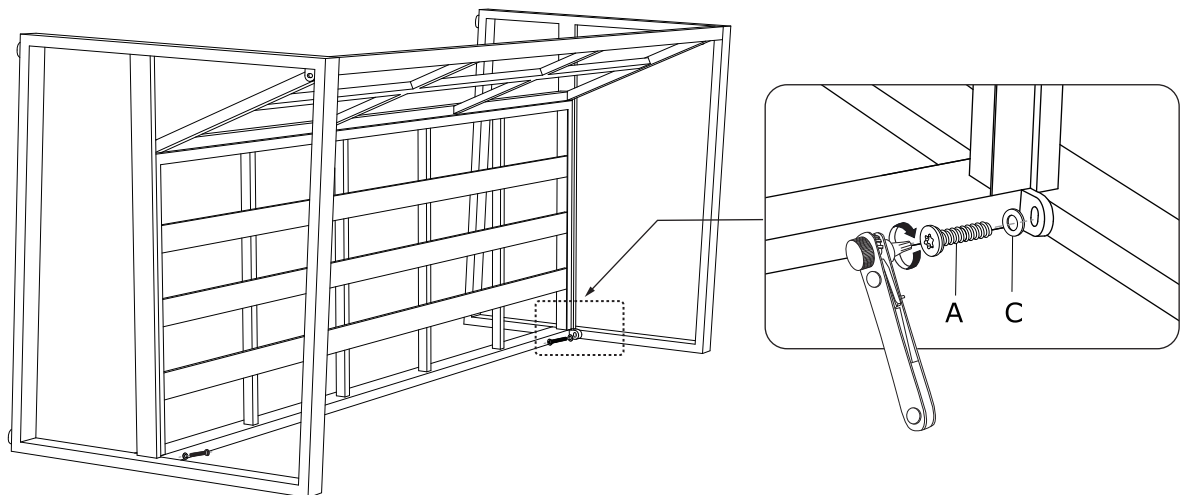
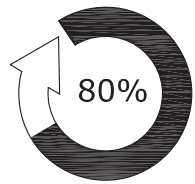

14

A x 2  M6x20 mm	C x 2  Ø6/Ø14 mm	E x 1  T25	Y x 1  T25	Z x 1  T25	
--	---	---	---	---	--



15

<p>E x 1</p>  <p>T25</p>	<p>Y x 1</p>  <p>T25</p>	<p>Z x 1</p>  <p>T25</p>	
---	---	---	--

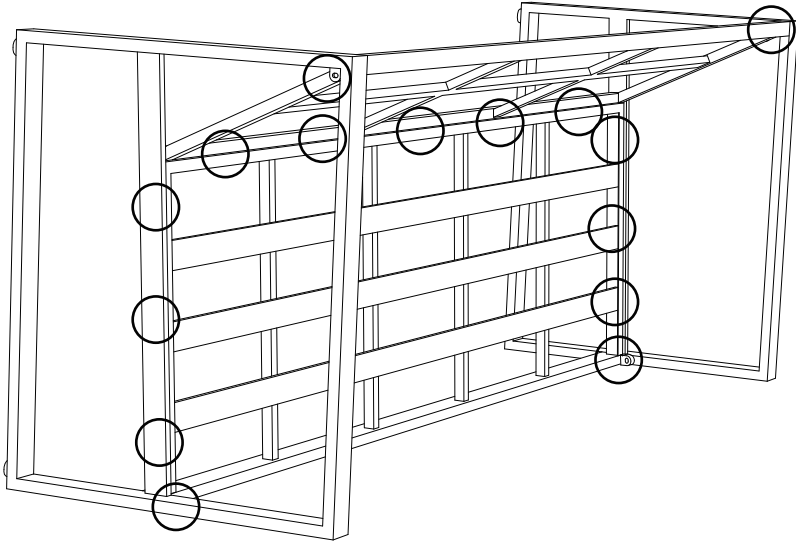
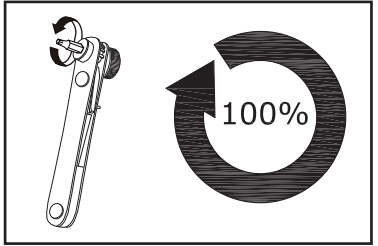

16

<p>D x 15</p>  <p>Ø16 mm</p>	
---	--

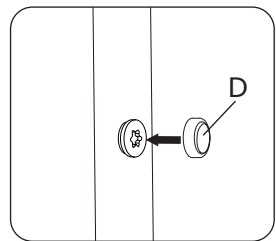
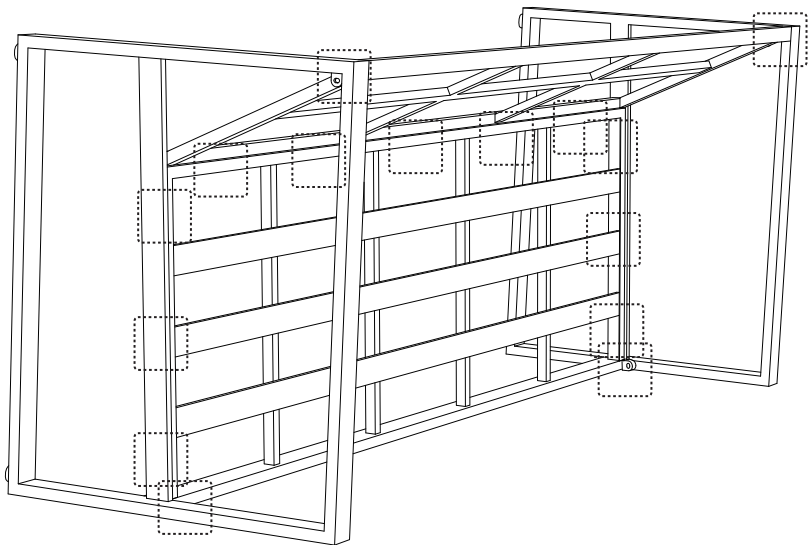

17

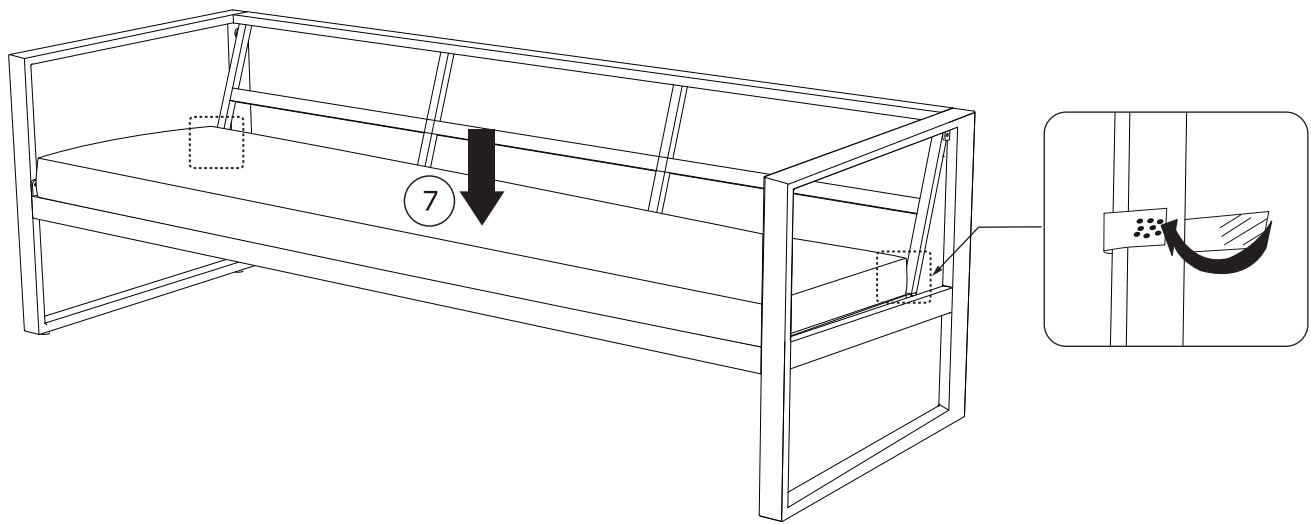

18

